



MONTÁŽNÍ NÁVOD

Postel s jednoduchým spojem
klasické přední nohy

www.asko.cz

Postel s latěmi	Str. 2-13
Postel s hřebeny	Str. 14-25

MONTÁŽNÍ NÁVOD

Postel s latěmi

Tato část návodu se věnuje variantě postele s latěmi. Pokud jste zakoupili variantu postele s hřebeny, pokračujte prosím od strany 14. tohoto návodu.

ČÁSTI POSTELE

SE STŘEDOVOU LATÍ

140x200
160x200
180x200
200x200

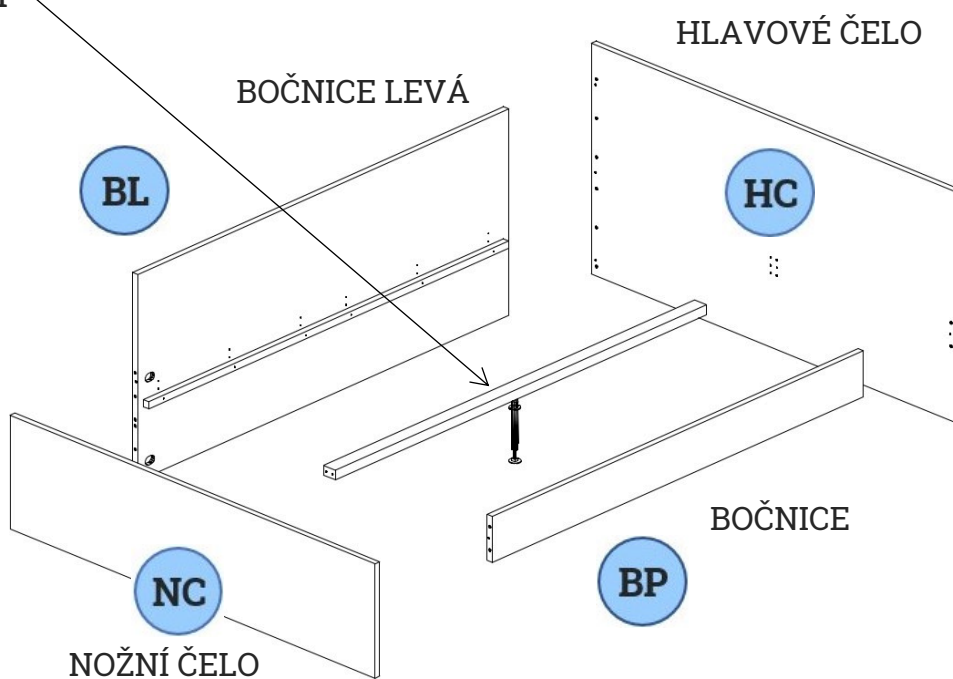

BEZ STŘEDOVÉ LATĚ

80x200
90x200
100x200
110x200
120x200
130x200

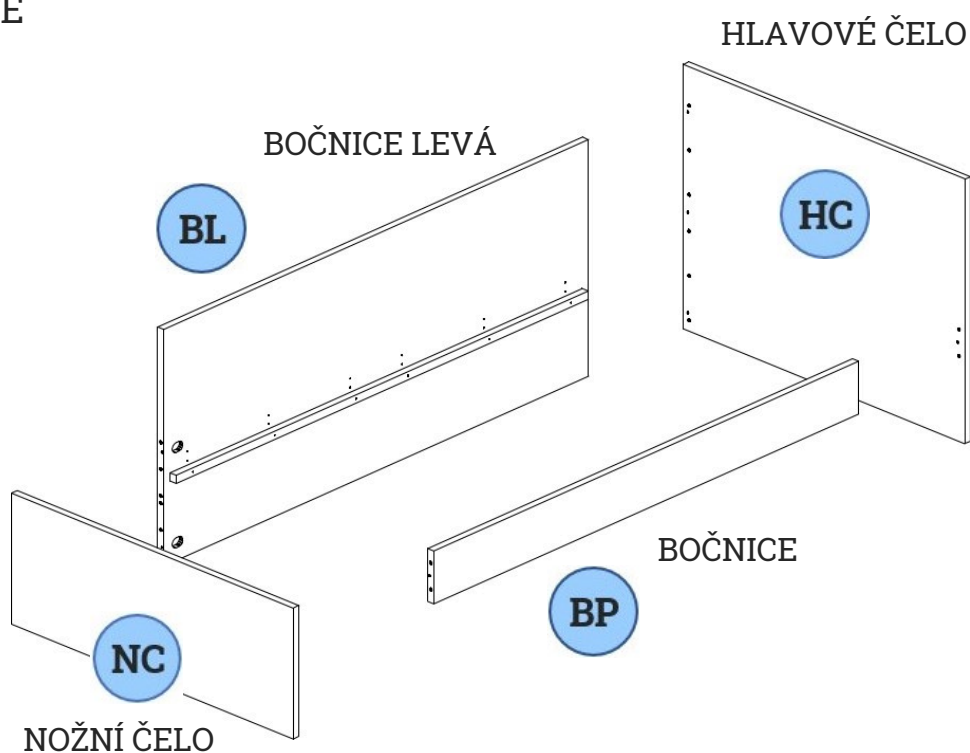

LATĚ DO BOČNIC

LB

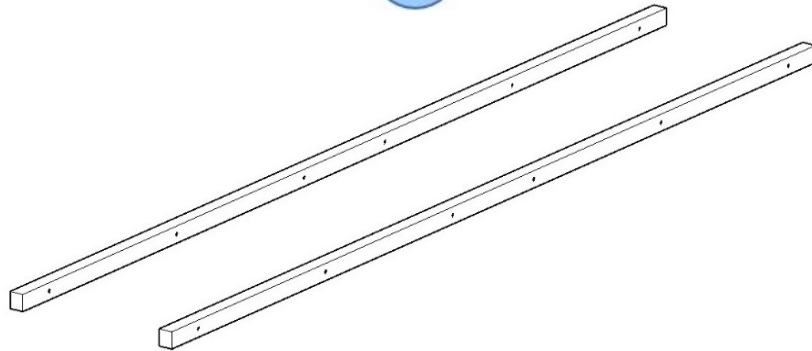

STŘEDOVÁ LAŤ

SL

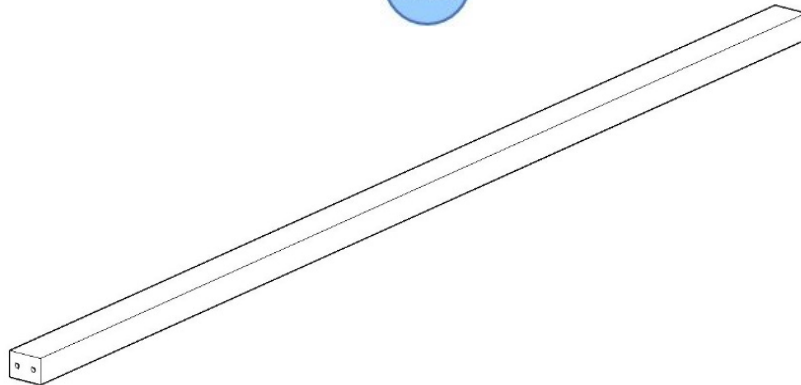

Obrázky uvedené níže jsou ilustrační, design Vaší postele se může lišit.

PŘÍKLAD BOČNICE LEVÉ

BL

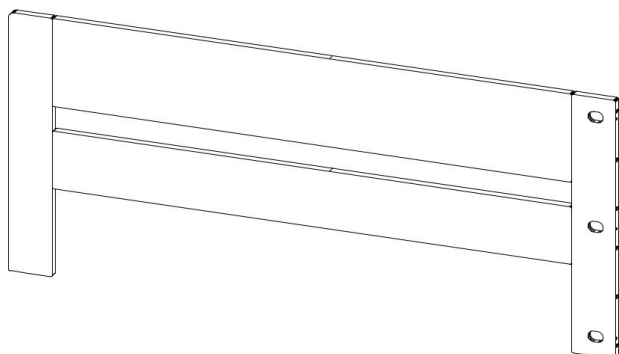

Pohledová část

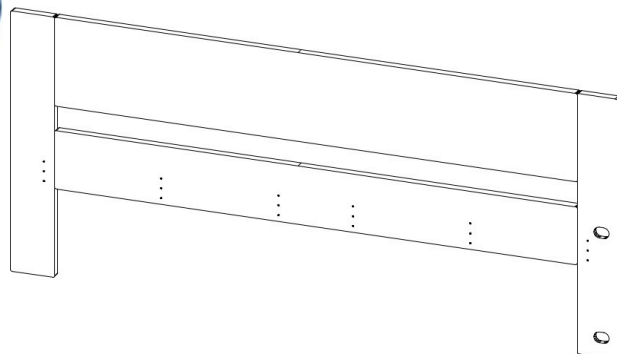

Vnitřní část

PŘÍKLAD BOČNICE LEVÉ

BL

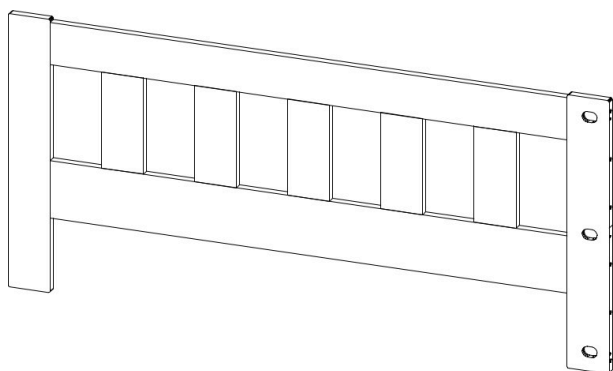

Pohledová část

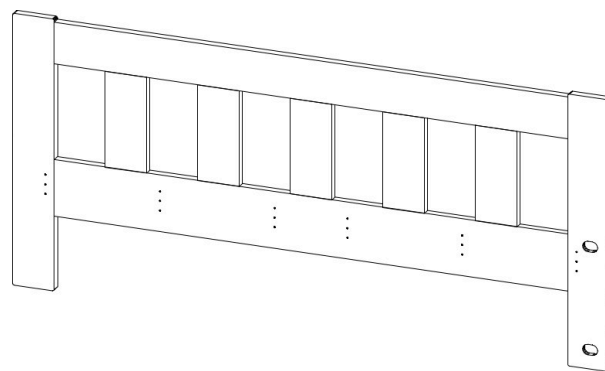

Vnitřní část

PŘÍKLAD BOČNICE PRAVÉ

BP

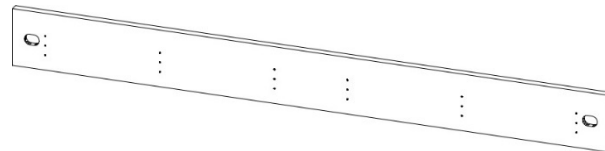
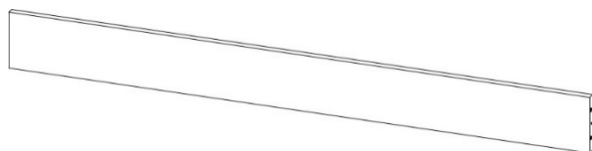

PŘÍKL D NOŽNÍHO ČELA

NC

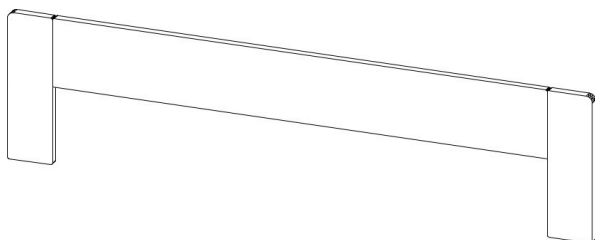

Pohledová část

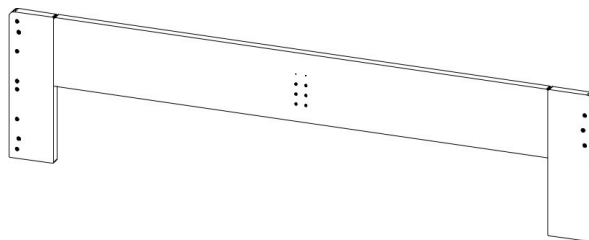

Vnitřní část

PŘÍKL D HLAVOVÉHO ČELA

HC

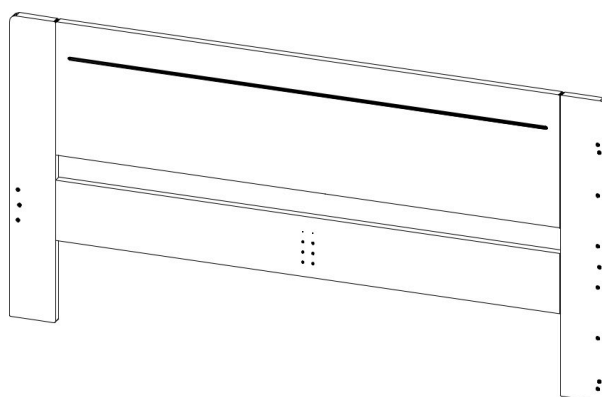
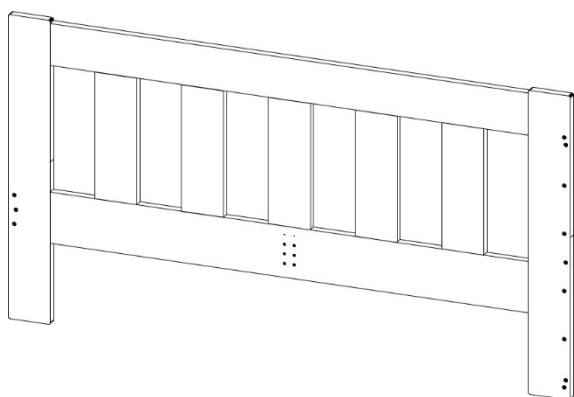

SOUPIS KOVÁNÍ

 1 7 ks	 2 7 ks	 3 7 ks	 4 7 ks
 5 Ø 8x40	 6 TORX 7x45 12 ks	 7 2 ks	 8 1 ks
 9 Ø 12 8-26 ks	 10 4x20 4 ks	 11 4x30 4 ks	 12 KLÍČ TORX 1 ks
 13 1 ks			

SESTAVENÍ POSTELE

1.

HC
1 ks

NC
1 ks

4
7 ks

2.

BP
1 ks

BL
1 ks

9
8-26 ks

3.

Pokud máte postel šířky 90-130 cm, tento krok přeskočte.

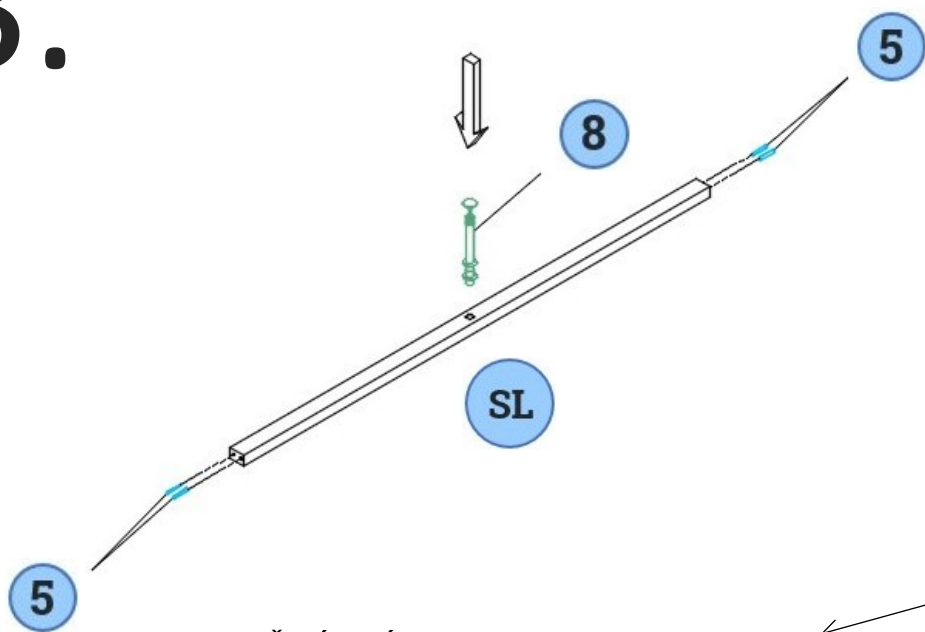

POUŽITÍ NÁSTAVCE NA NOHU NA
ZÁKLADĚ VÝŠKOVÉHO UMÍSTĚNÍ
LATÍ

SL

1 ks

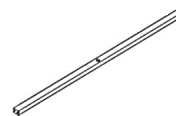

5

4 ks

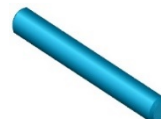

8

1 ks



4.

V tomto kroku dobře zvažte, v jaké výšce bude umístěna středová lať (viz. schéma výšky lať níže na této straně). V případě postele šířky 90-130 cm krok umístění středové lať přeskočte.

Schéma výšky lať

Laťe do bočnic a středovou lať můžete připevnit do několika pozic. Výšková pozice laťi ovlivňuje tyto dvě věci:

- 1) Výslednou výšku ložné plochy (pozor, berte v potaz i výšku roštu).
- 2) Kolik cm matrace bude zapuštěno v rámu postele (doporučujeme minimálně 5-8 cm).

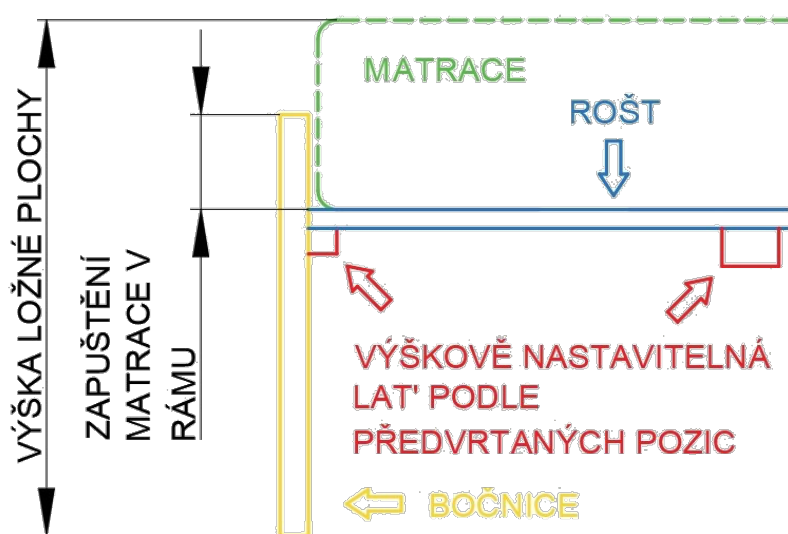

HC

1 ks

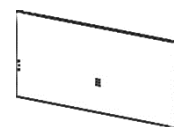

NC

1 ks



BP

1 ks



BL

1 ks

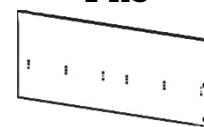

SL

1 ks

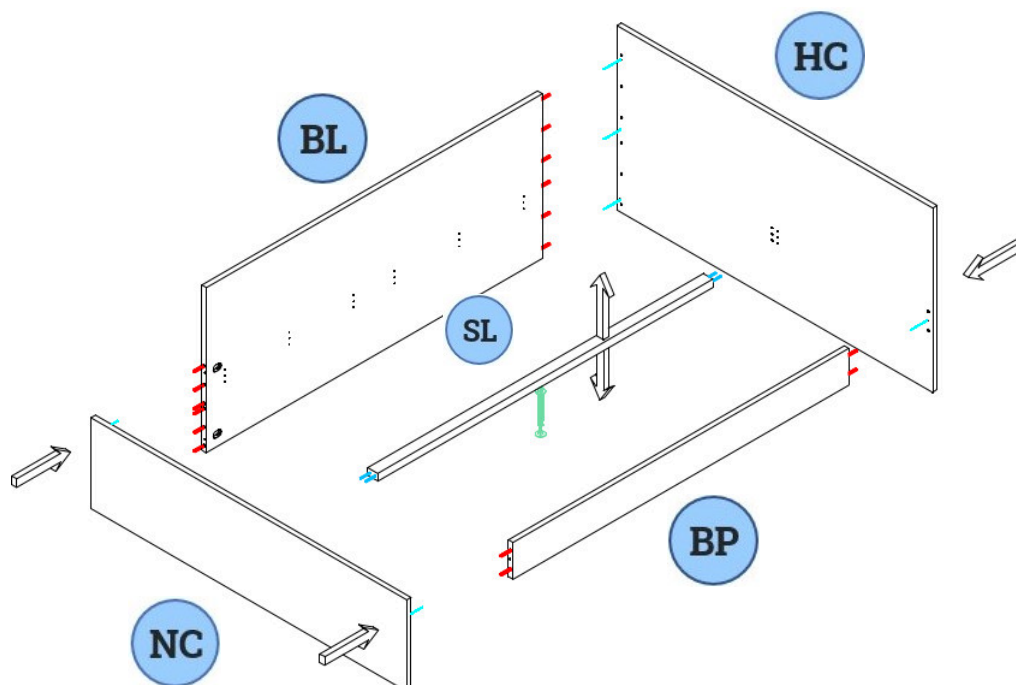

5.

Před stažením šroubového spoje pečlivě zkontrolujte, že k sobě dílce bočnice a čela postele dokonale doléhají. V případě nutnosti použijte gumovou paličku. Až poté je možné šroubový spoj dotáhnout.

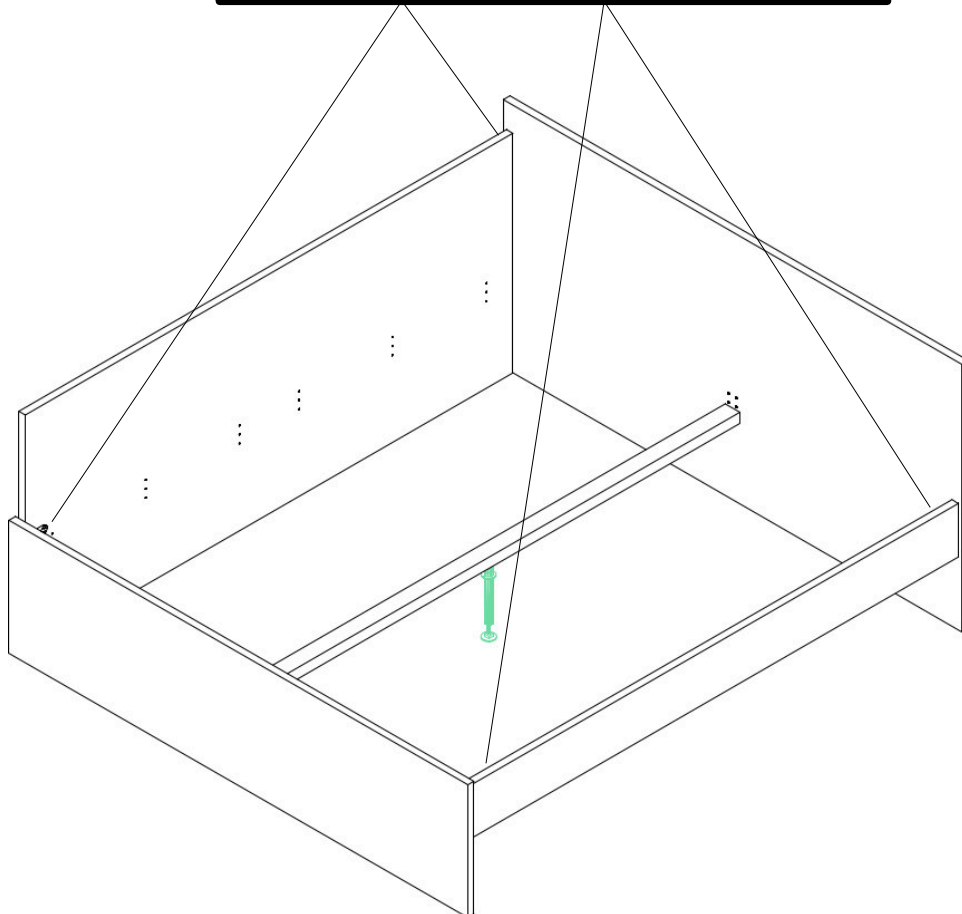
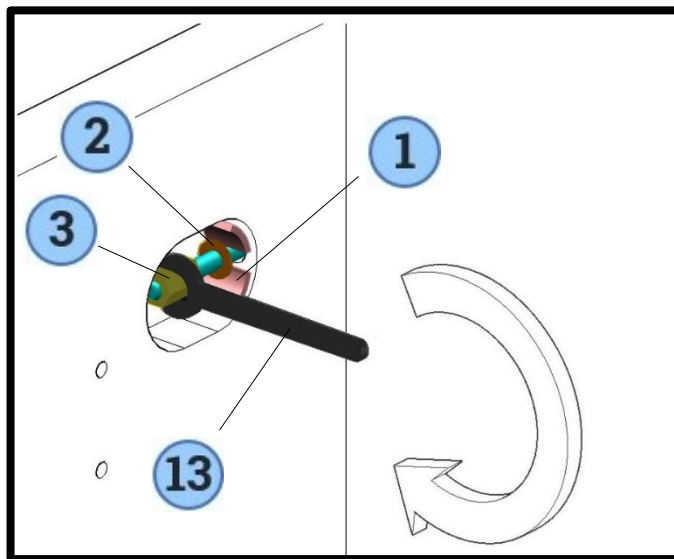

1

7 ks



2

7 ks



3

7 ks

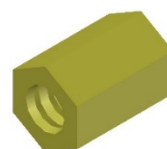

13

1 ks



6.

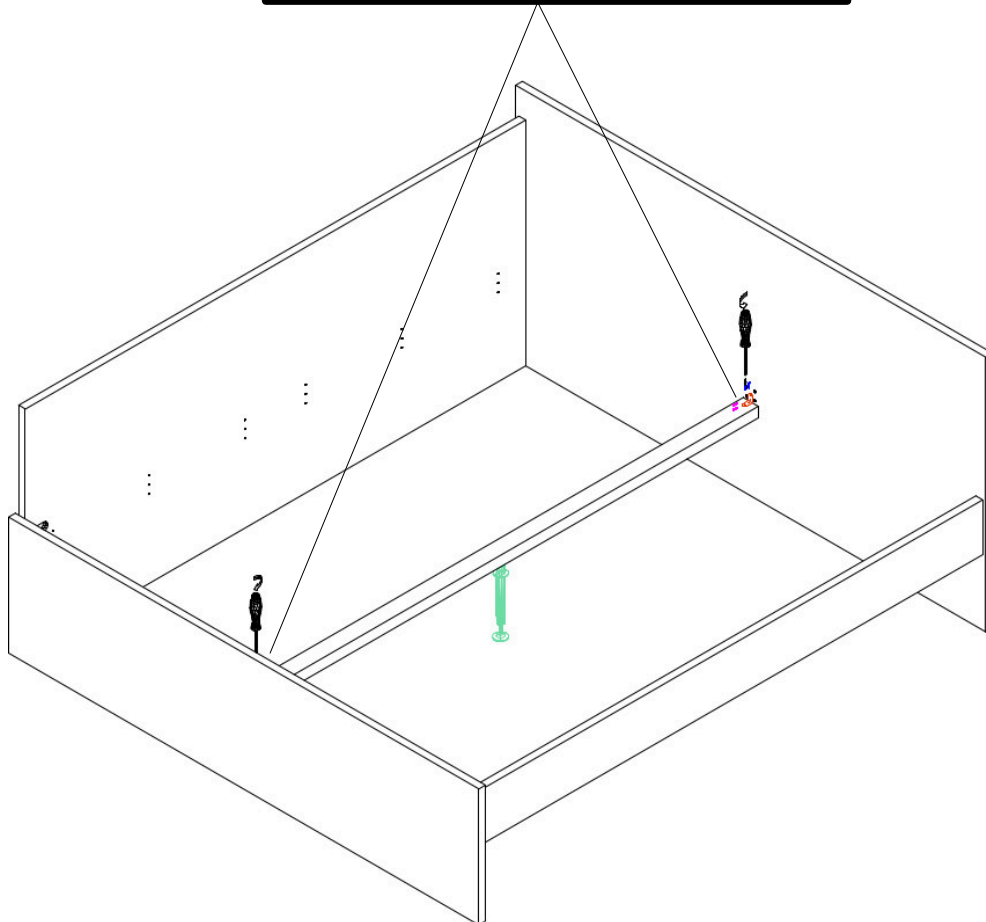
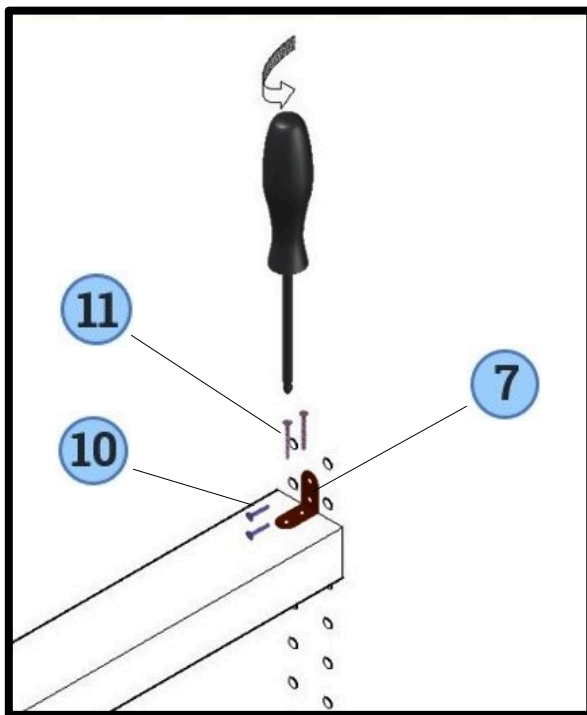

10

4 ks



11

4 ks



7

2 ks



7.

V tomto kroku dobře zvažte, v jaké výšce bude umístěna středová lať (viz. schéma výšky latí níže na této straně). V případě postele šířky 90-130 cm krok umístění středové latě přeskočte.

Schéma výšky latí

Latě do bočnic a středovou lať můžete připevnit do několika pozic. Výšková pozice latí ovlivňuje tyto dvě věci:

- 1) Výslednou výšku ložné plochy (pozor, berte v potaz i výšku roštu).
- 2) Kolik cm matrace bude zapuštěno v rámu postele (doporučujeme minimálně 5-8 cm).

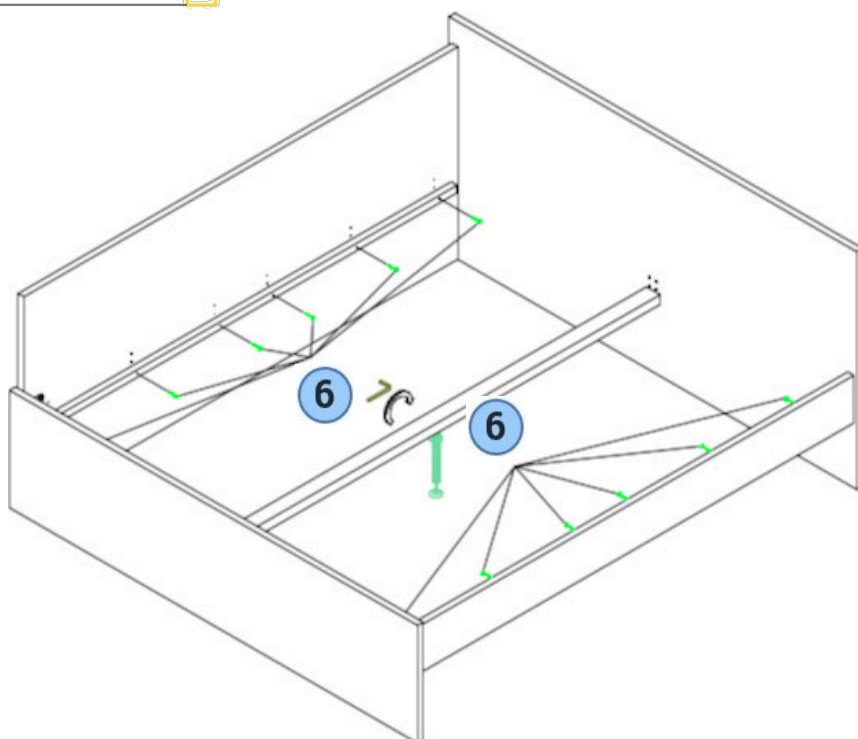
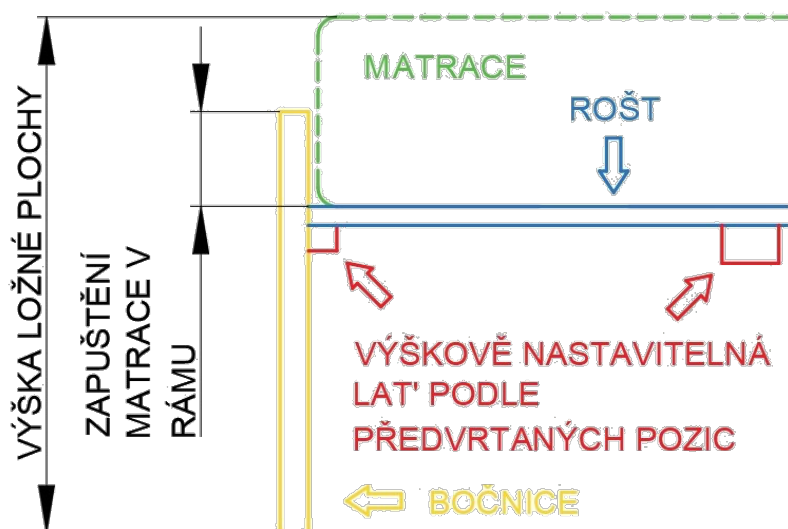

LB

2 ks

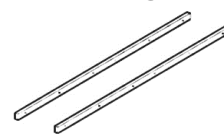

6

TORX

7x45

12 ks



12

KLÍČ

TORX

1 ks



MONTÁŽNÍ NÁVOD

Postel s hřebeny

Tato část návodu se věnuje variantě postele s hřebeny. Pokud jste zakoupili variantu postele s latěmi, vraťte se prosím na stranu 3. tohoto návodu.

SE STŘEDOVOU LATÍ

140x200
160x200
180x200
200x200

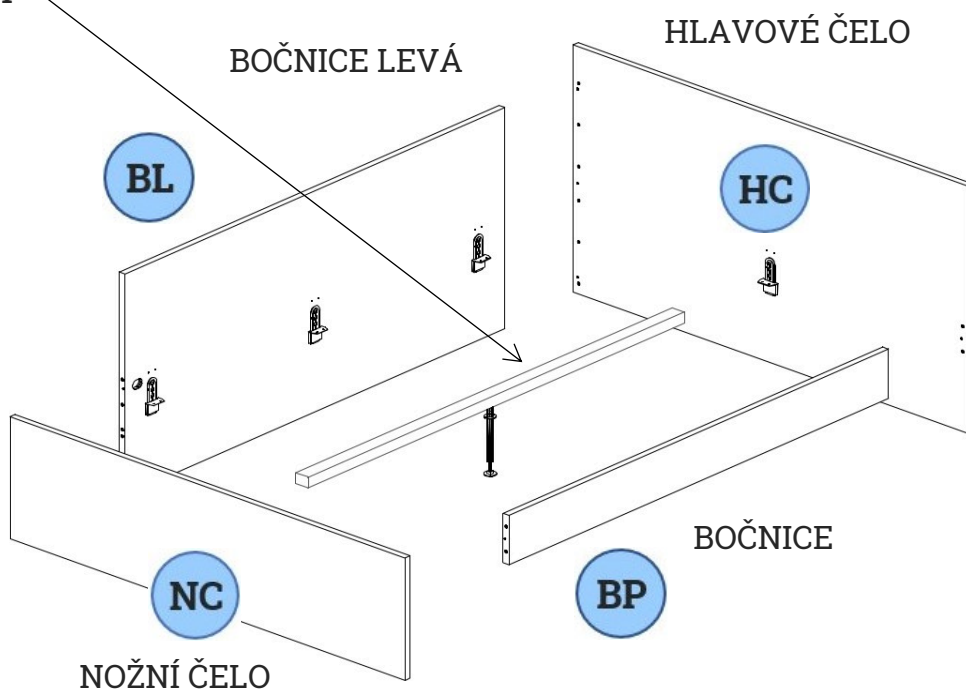

BEZ STŘEDOVÉ LATĚ

80x200
90x200
100x200
110x200
120x200
130x200

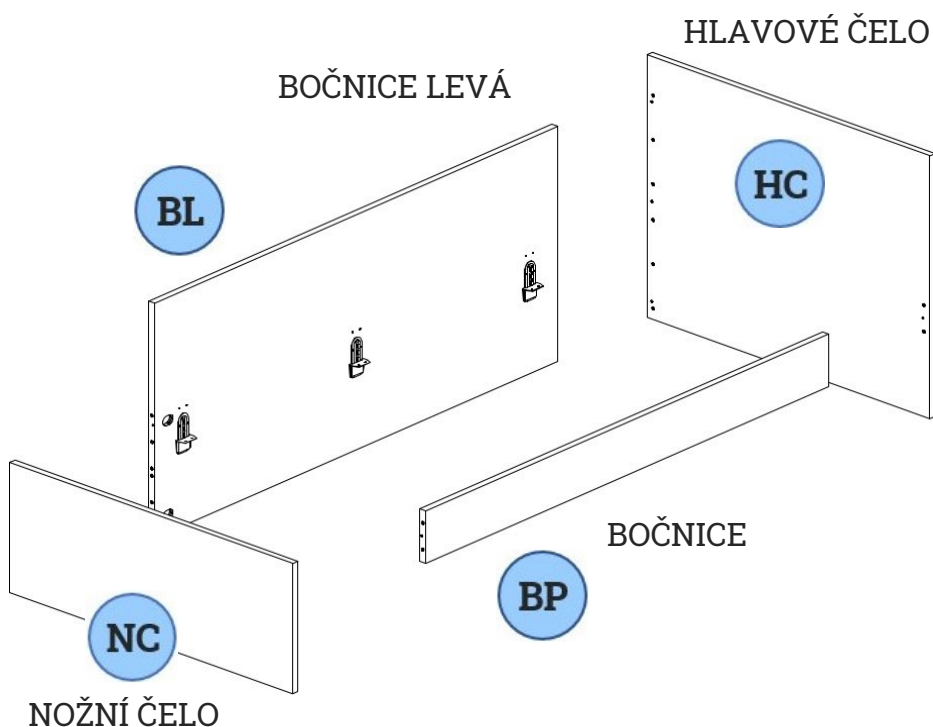

HÁKY DO BOČNIC

HB

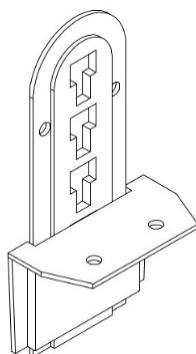

STŘEDOVÁ LAŤ

SL

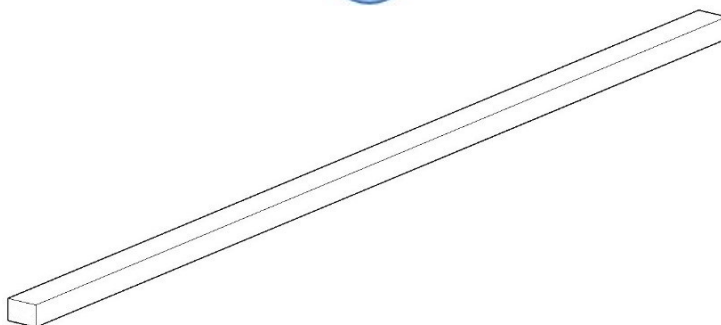

Obrázky uvedené níže jsou ilustrační, design Vaší postele se může lišit.

PŘÍKLAD BOČNICE LEVÉ

BL

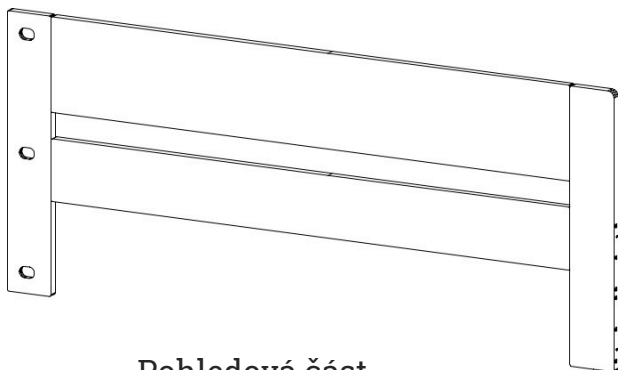

Pohledová část

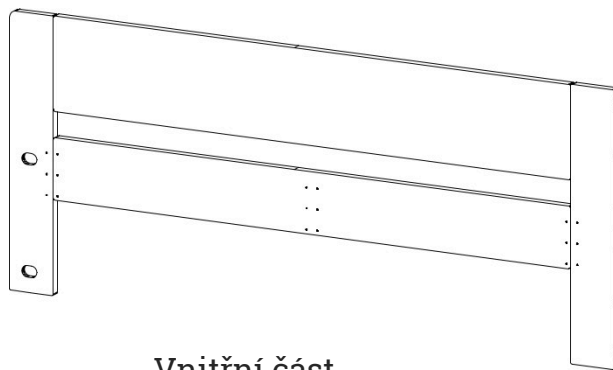

Vnitřní část

PŘÍKLAD BOČNICE LEVÉ

BL

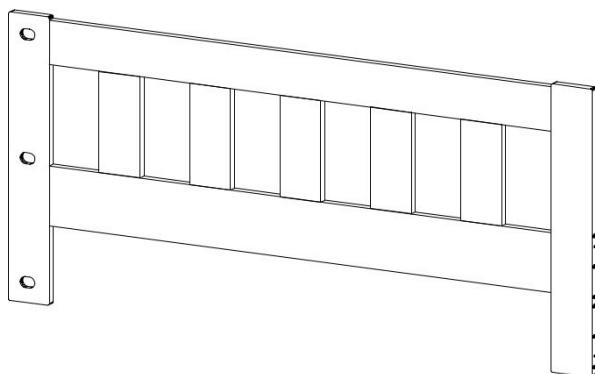

Pohledová část

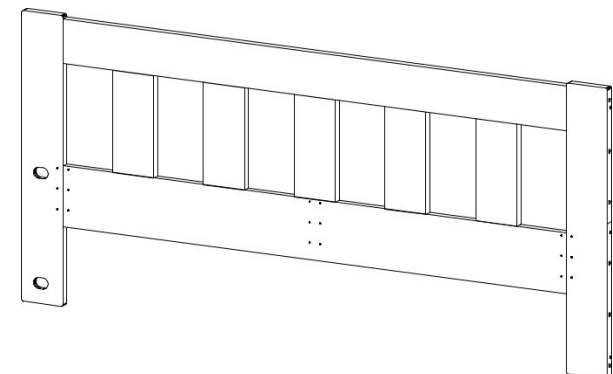

Vnitřní část

PŘÍKLAD BOČNICE PRAVÉ

BP

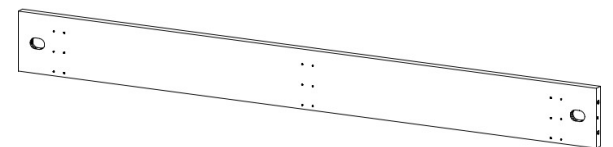
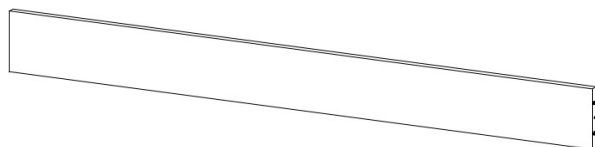

PŘÍKL D NOŽNÍHO ČELA

NC

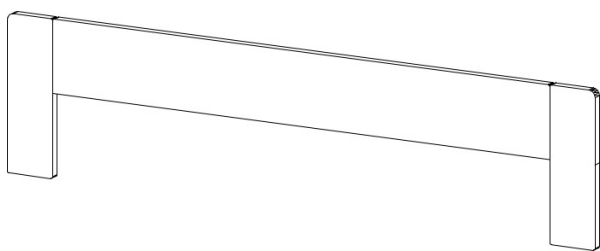

Pohledová část

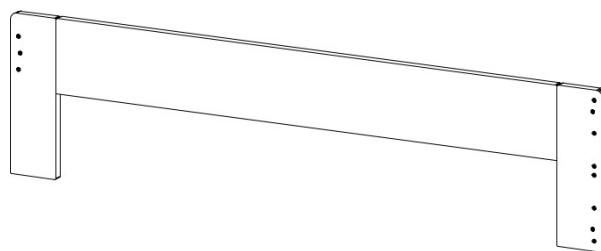







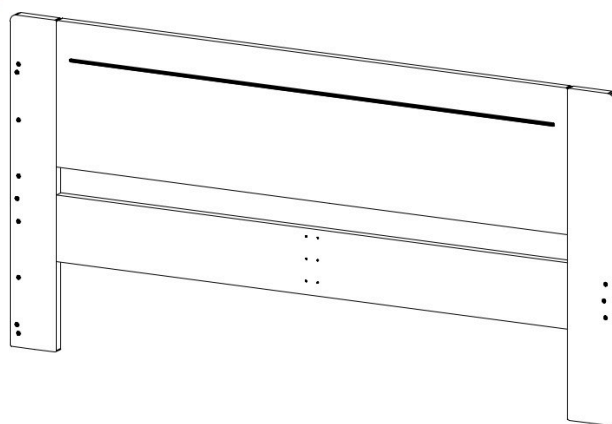
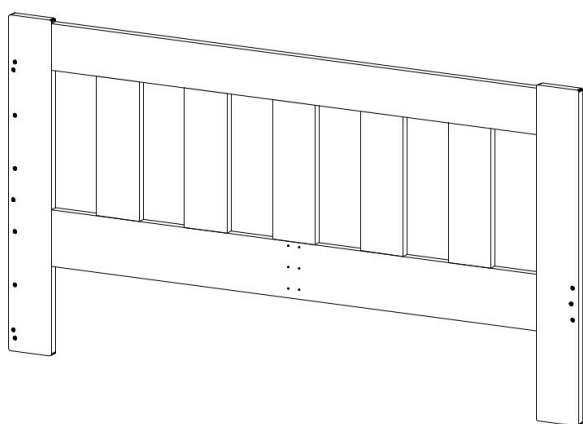

Vnitřní část

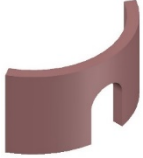
PŘÍKL D HLAVOVÉHO ČELA

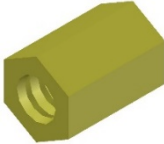
HC

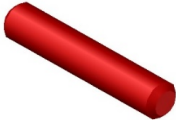
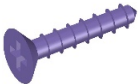

SOUPIS KOVÁNÍ

 1 7 ks	 2 7 ks	 3 7 ks	 4 7 ks
 5 32 ks	 6 8 ks	 7 1 ks	 8 Ø 12 8-26 ks
 9 4x30 4 ks	 10 1 ks		

SESTAVENÍ POSTELE

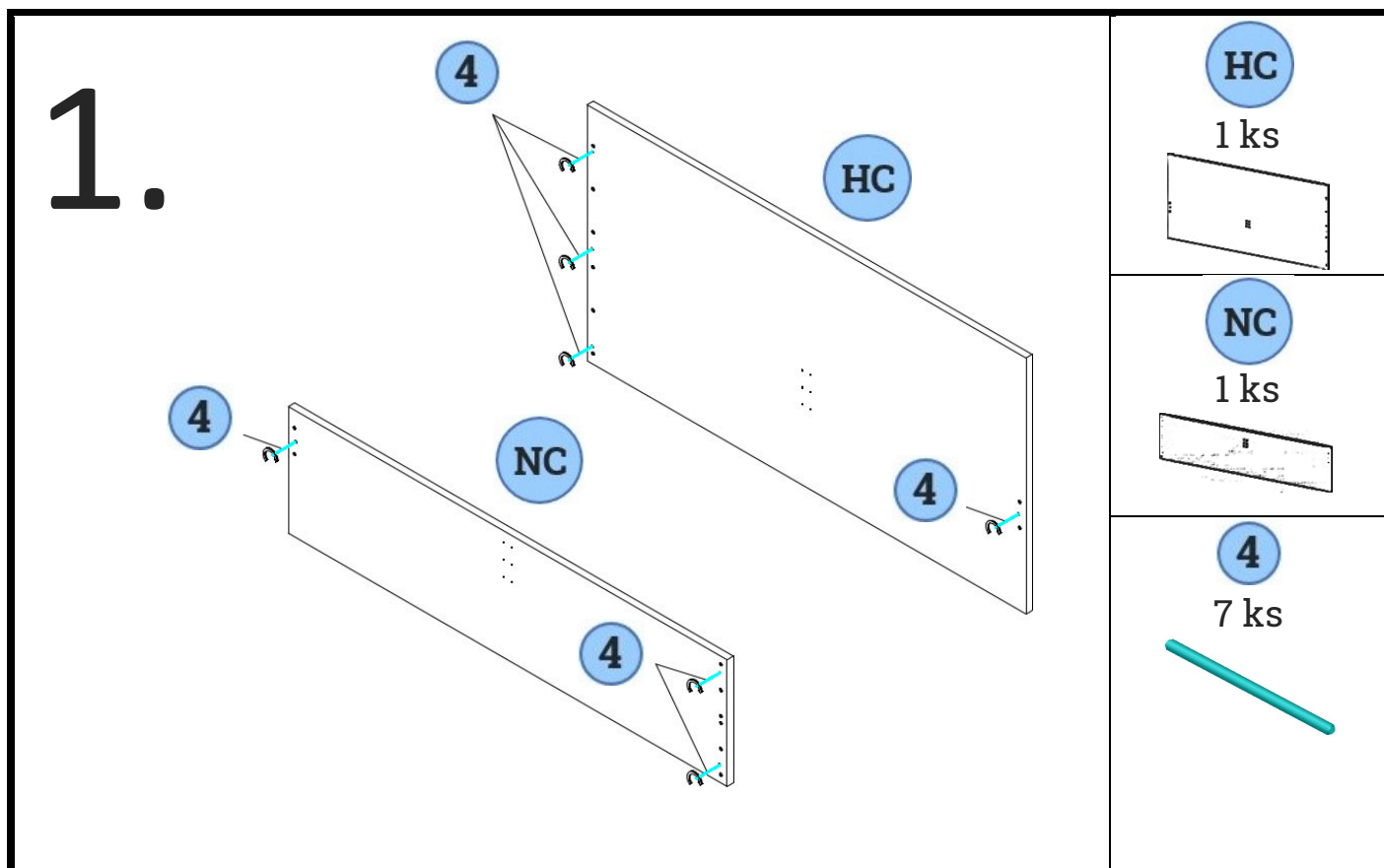

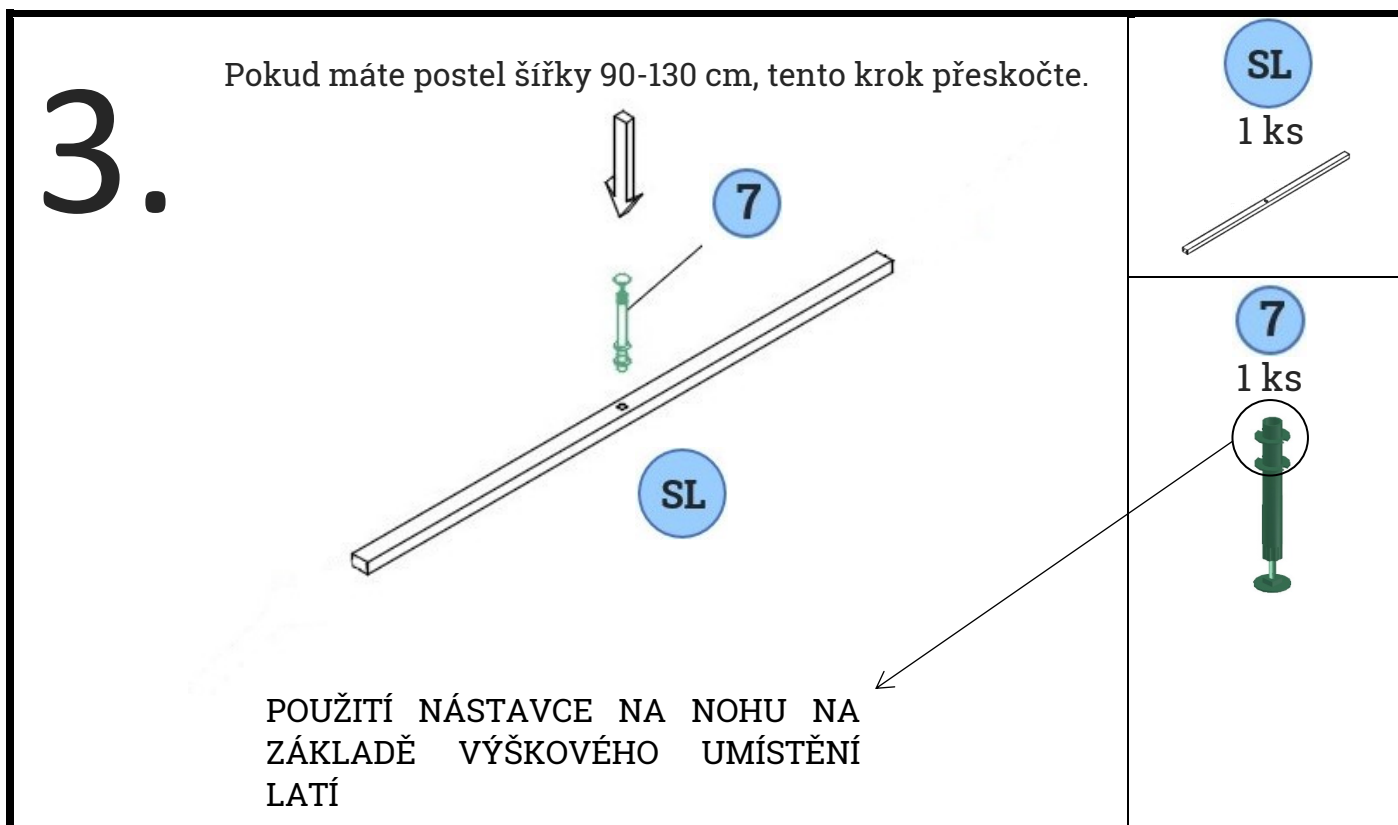
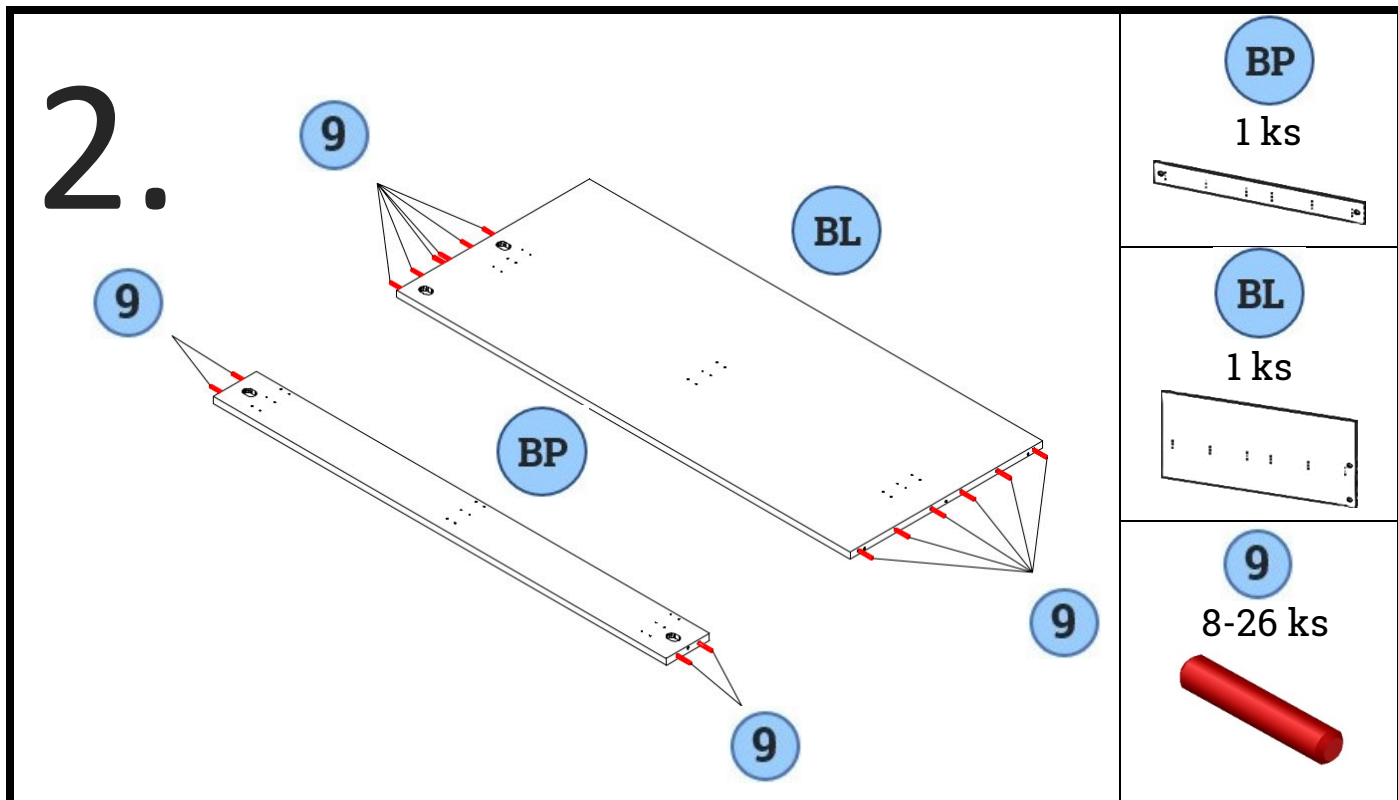

4.

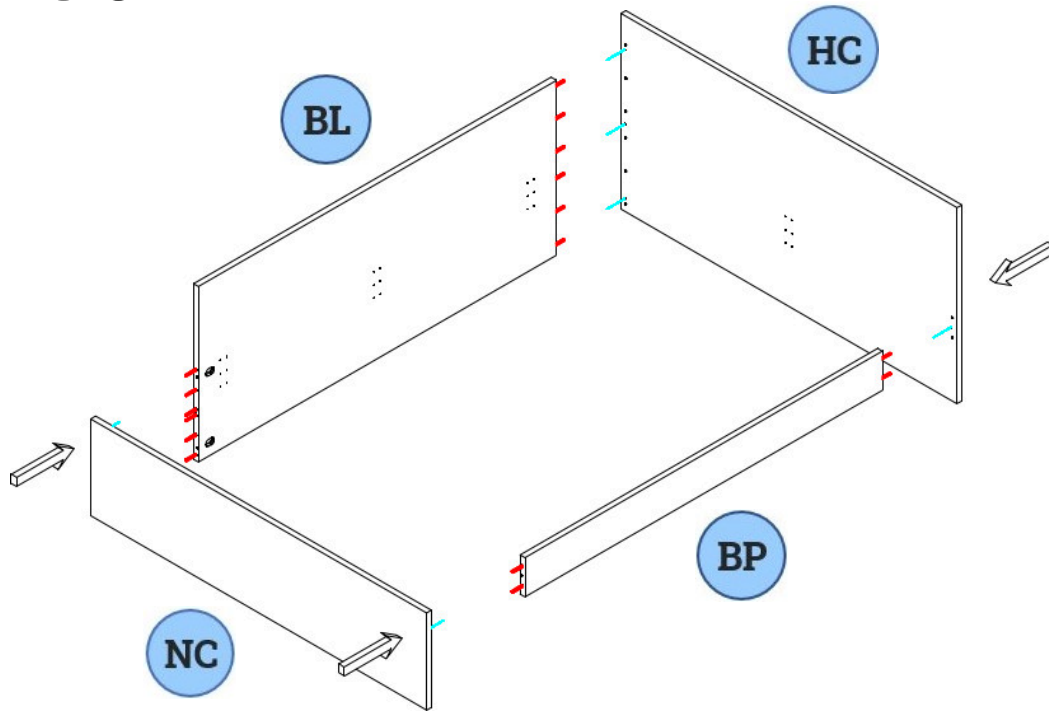

HC

1 ks

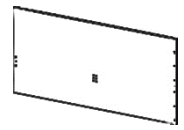

NC

1 ks



BP

1 ks



BL

1 ks

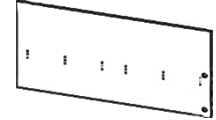

5.

Před stažením šroubového spoje pečlivě zkontrolujte, že k sobě dílce bočnice a čela postele dokonale doléhají. V případě nutnosti použijte gumovou paličku. Až poté je možné šroubový spoj dotáhnout.

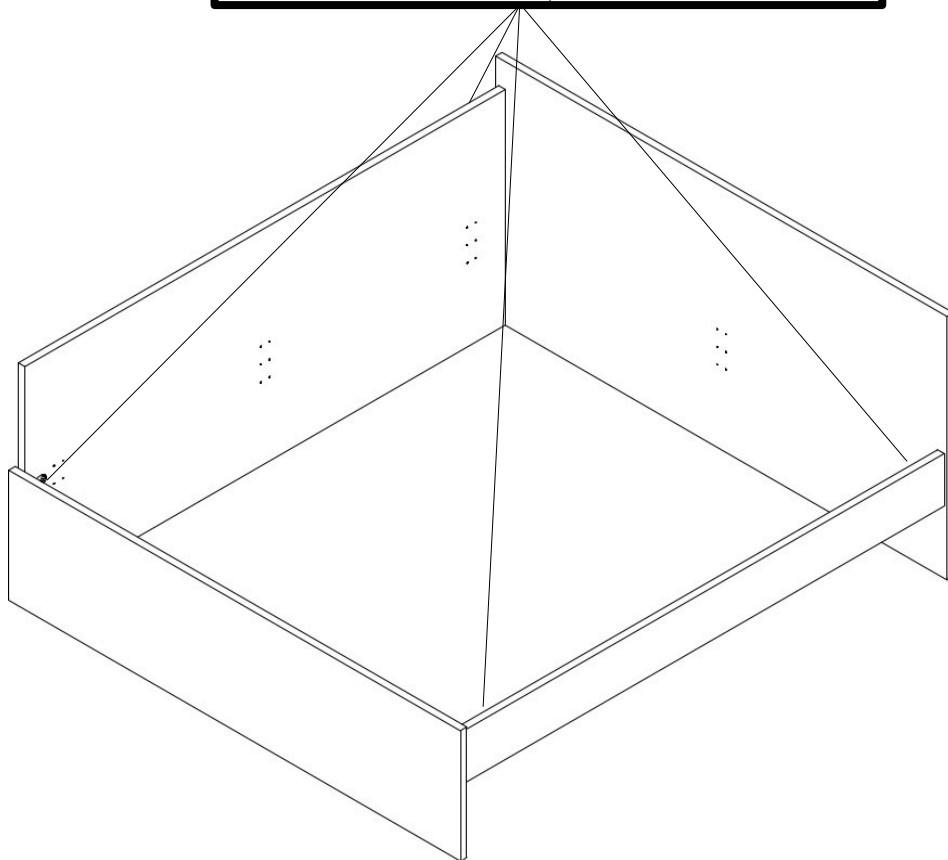
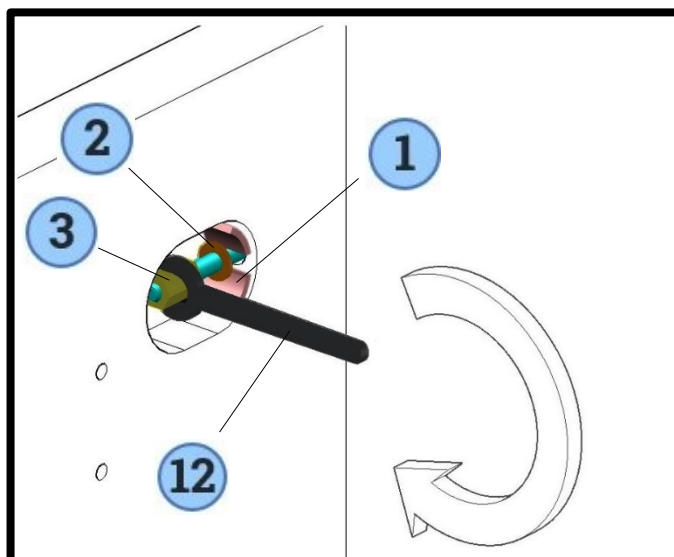

1

7 ks

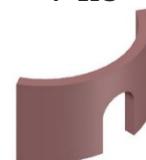

2

7 ks



3

7 ks



12

1 ks



6.

V tomto kroku dobře zvažte, v jaké výšce bude umístěna středová lat' a latě na bočnicích (viz. schéma výšky latí níže na této straně). V případě postele šířky 90-130 cm krok umístění středové latě přeskočte.

Schéma výšky latí

Latě do bočnic a středovou lat' můžete připevnit do několika pozic. Výšková pozice latí ovlivňuje tyto dvě věci:

- 1) Výslednou výšku ložné plochy (pozor, berte v potaz i výšku roštu).
- 2) Kolik cm matrace bude zapuštěno v rámu postele (doporučujeme minimálně 5-8 cm).

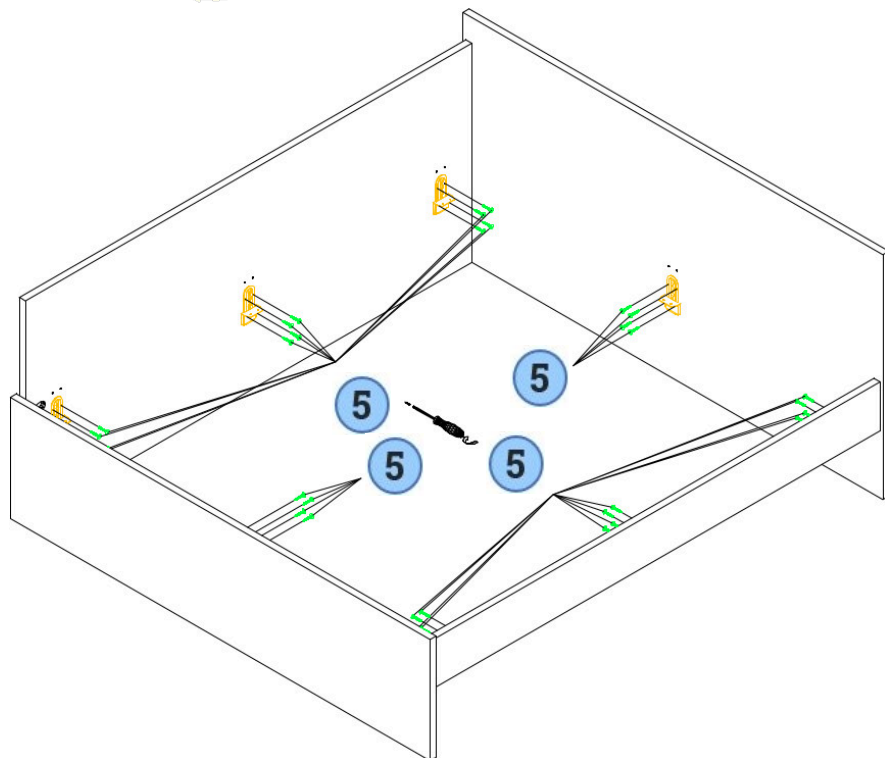
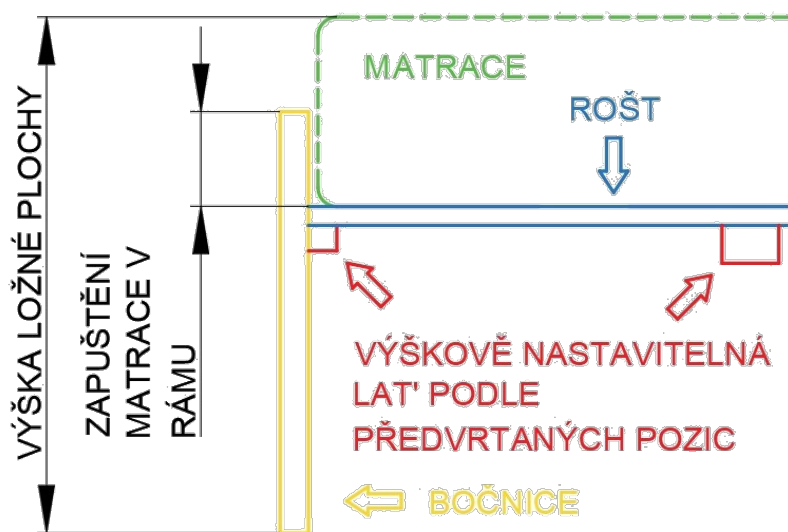

6
8 ks



5
32 ks



7.

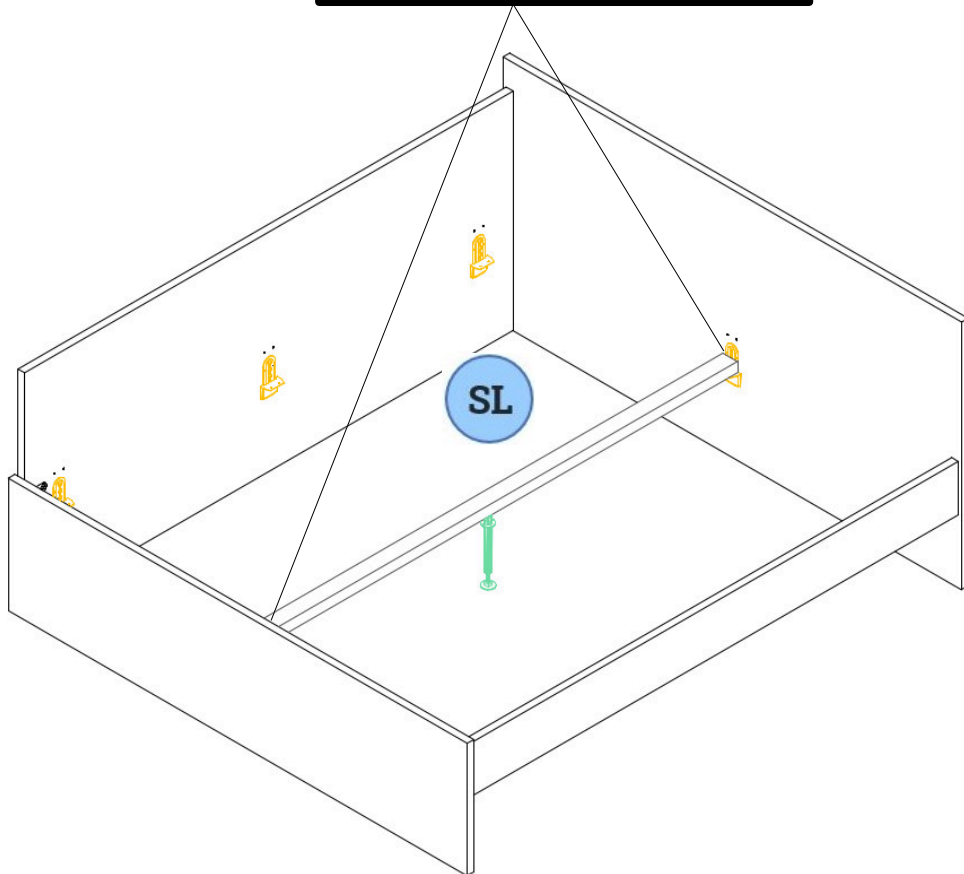
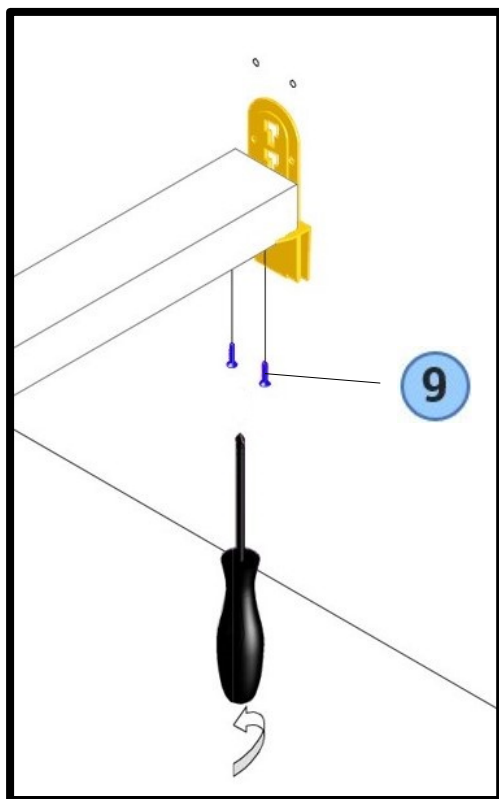

SL

1 ks

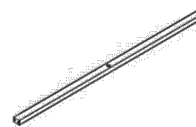

9

4 ks

