

**ASKO**<sup>®</sup>  
NÁBYTEK

## **MONTÁŽNÍ NÁVOD**

Postel s dvojitým spojem,  
přední nohy rohové  
typ FUTON

[www.asko.cz](http://www.asko.cz)

# ČÁSTI POSTELE

SE STŘEDOVOU LATÍ

140x200
160x200
180x200
200x200

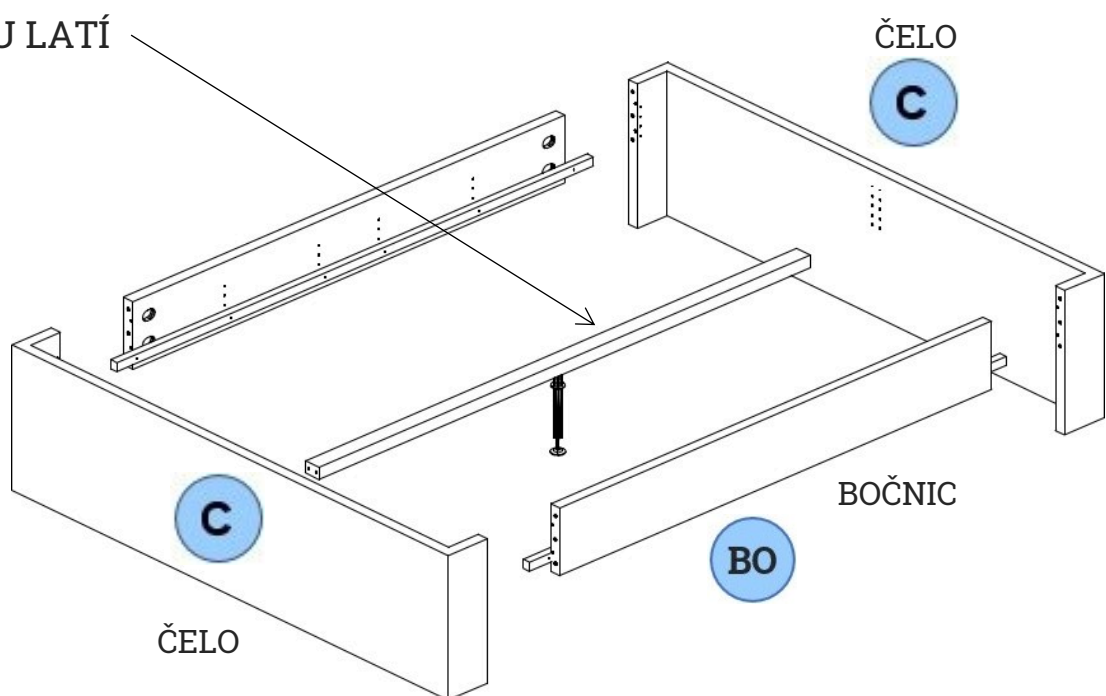

BEZ STŘEDOVÉ LATĚ

80x200
90x200
100x200
110x200
120x200
130x200

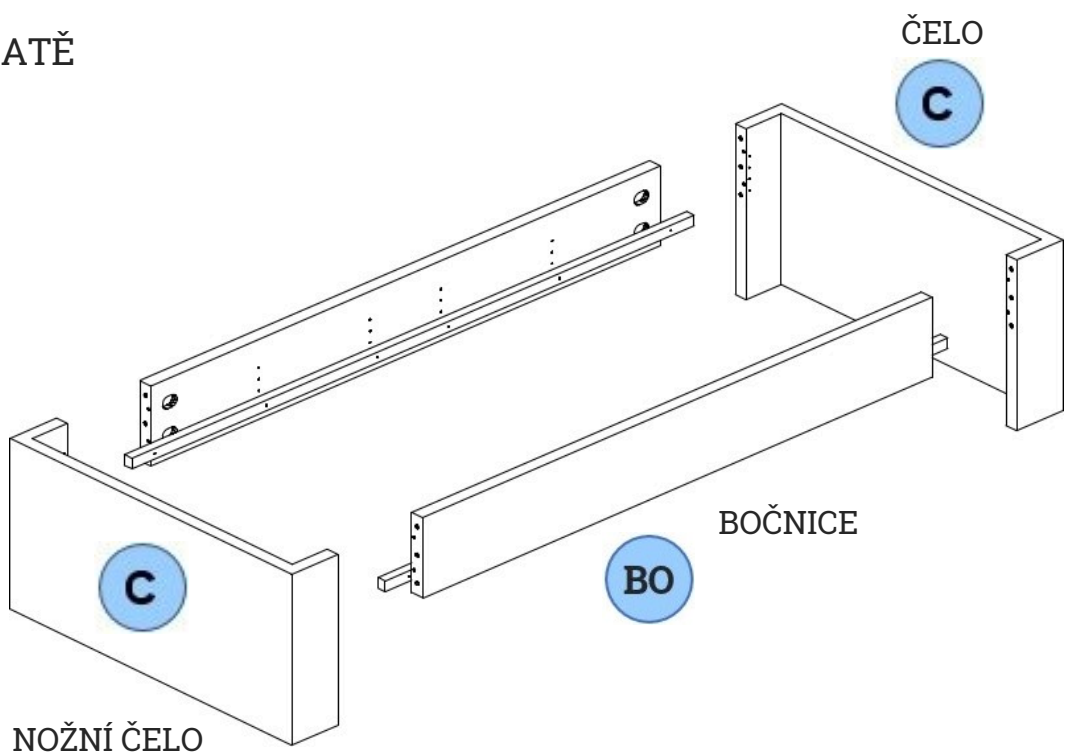

LATĚ DO BOČNIC

LB

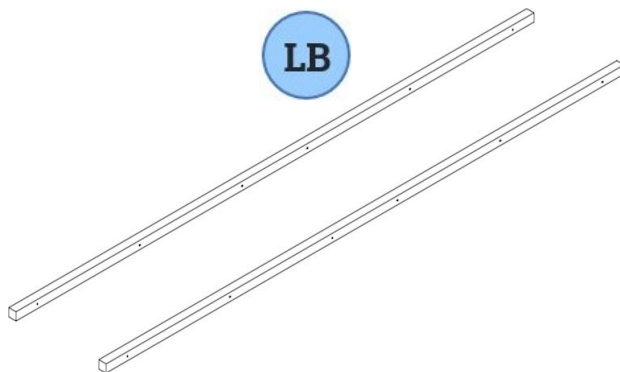

STŘEDOVÁ LATĚ

SL

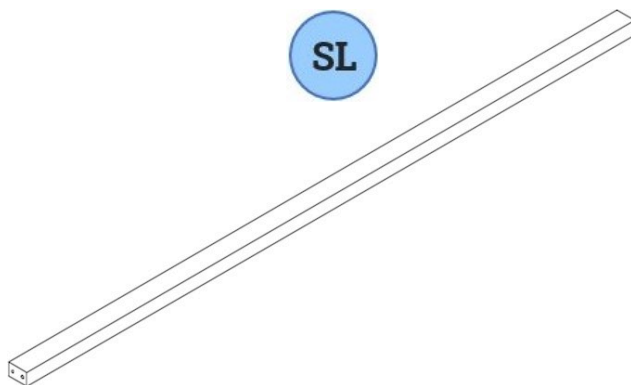

Obrázky uvedené níže jsou ilustrační, design Vaší postele se může lišit.

### PŘÍKLAD BOČNICE

BO

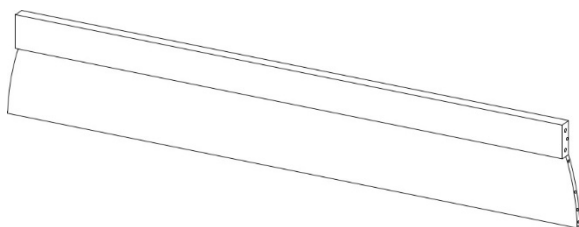

Pohledová část

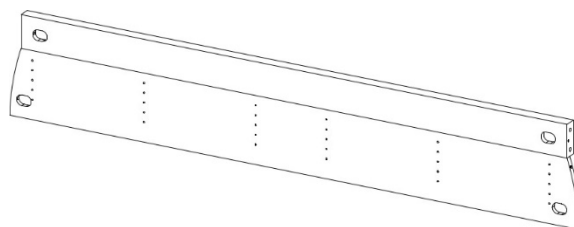

Vnitřní část

### PŘÍKLAD ČELA

C

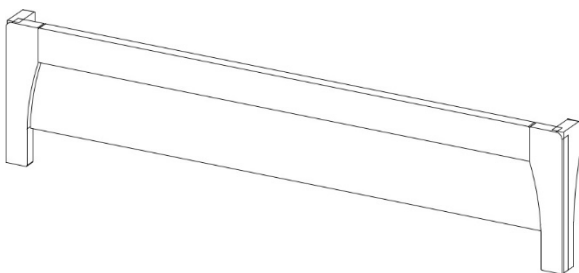

Pohledová

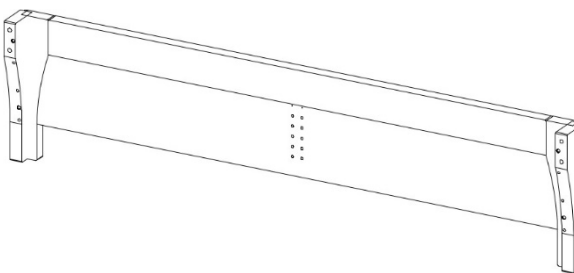

Vnitřní část

## SOUPIS KOVÁNÍ

 <p><b>1</b> 8 ks</p>	 <p><b>2</b> 8 ks</p>	 <p><b>3</b> 8 ks</p>	 <p><b>4</b> 8 ks</p>
 <p><b>5</b> Ø 8x40 4 ks</p>	 <p><b>6</b> TORX 7x45 12 ks</p>	 <p><b>7</b> 2 ks</p>	 <p><b>8</b> 1 ks</p>
 <p><b>9</b> Ø 12 8-26 ks</p>	 <p><b>10</b> 4x20 4 ks</p>	 <p><b>11</b> 4x30 4 ks</p>	 <p><b>12</b> KLÍČ TORX 1 ks</p>
 <p><b>13</b> 1 ks</p>			

# SESTAVENÍ POSTELE

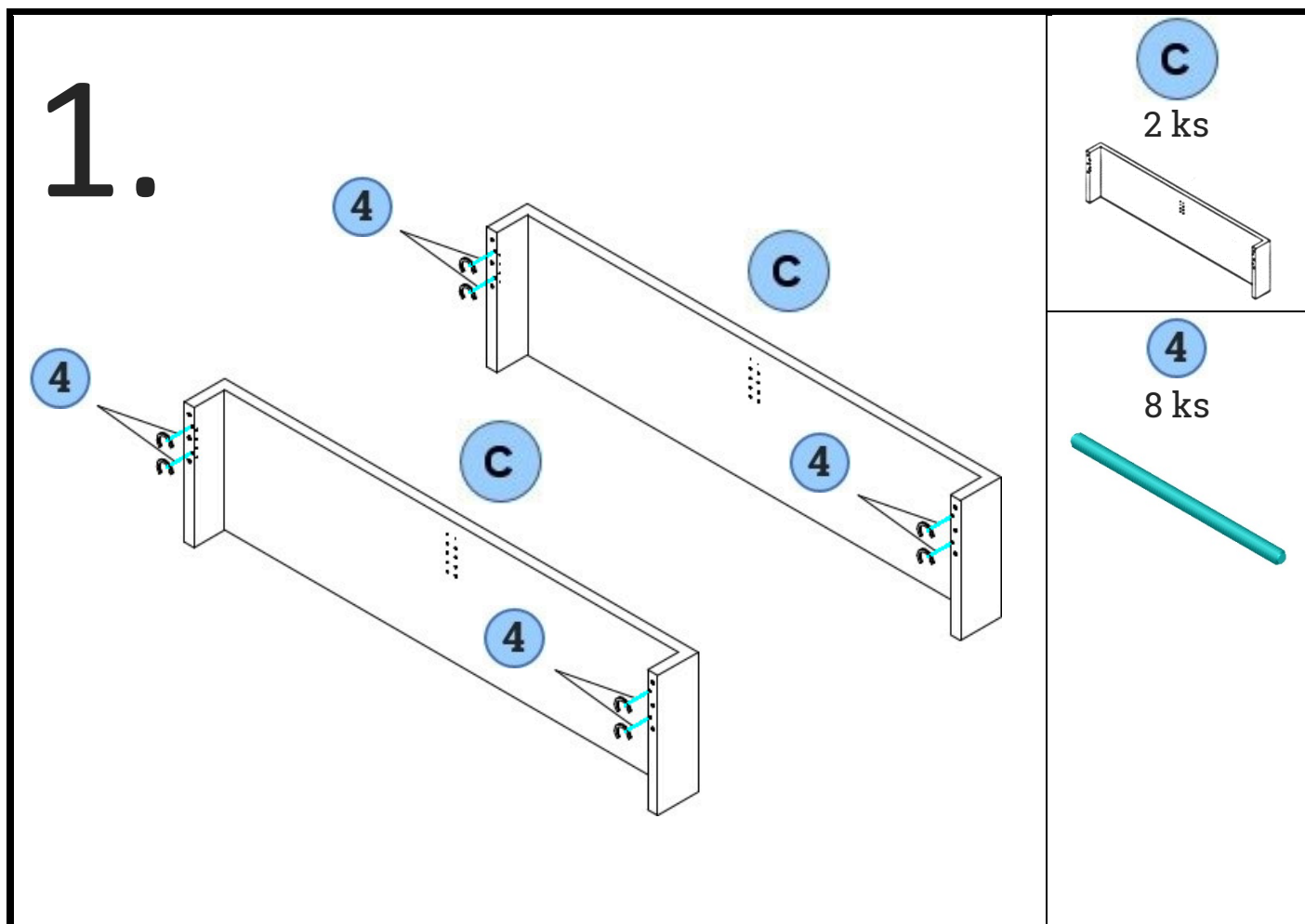

# 2.

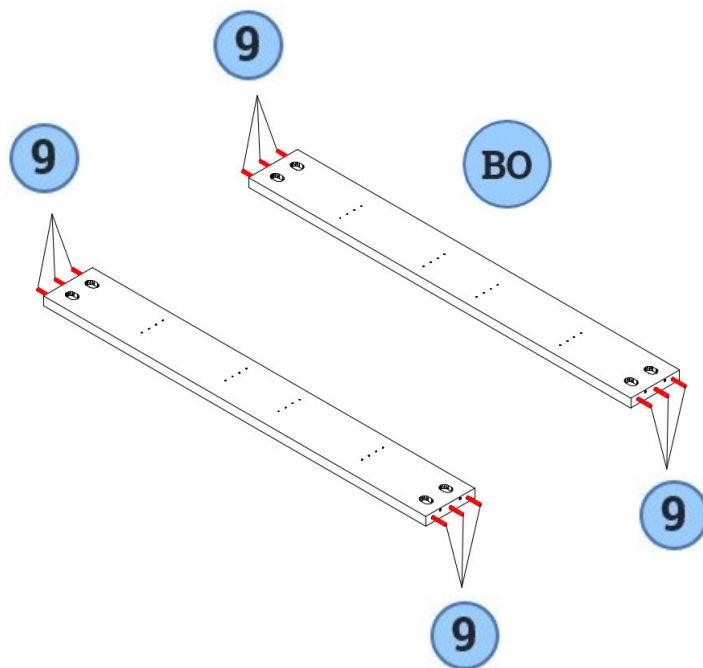

BO

2 ks

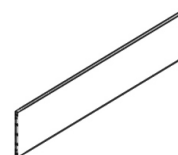

9

8-26 ks

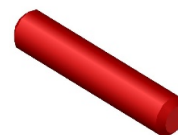

# 3.

Pokud máte postel šířky 90-130 cm, tento krok přeskočte.

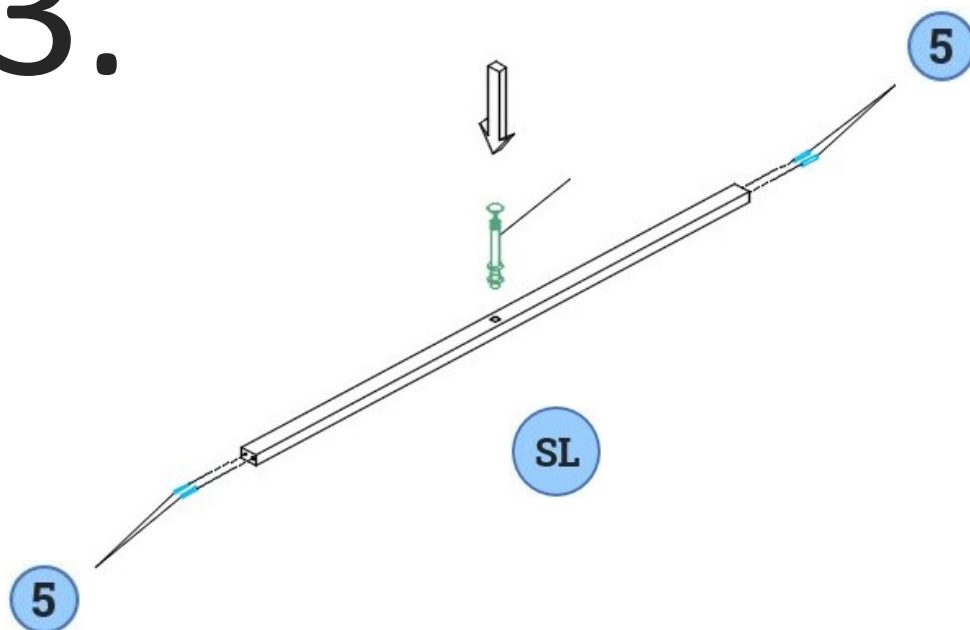

SL

1 ks

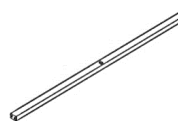

5

4 ks

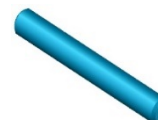

8

1 ks



POUŽITÍ NÁSTAVCE NA NOHU NA ZÁKLADĚ VÝŠKOVÉHO UMÍSTĚNÍ LATÍ

# 4.

V tomto kroku dobře zvažte, v jaké výšce bude umístěna středová lať (viz. schéma výšky lať níže na této straně). V případě postele šířky 90-130 cm krok umístění středové latě přeskočte.

## Schéma výšky lať

Lať do bočnic a středovou lať můžete připevnit do několika pozic. Výšková pozice laťi ovlivňuje tyto dvě věci:

- 1) Výslednou výšku ložné plochy (pozor, berte v potaz i výšku roštu).
- 2) Kolik cm matrace bude zapuštěno v rámu postele (doporučujeme minimálně 5-8 cm).

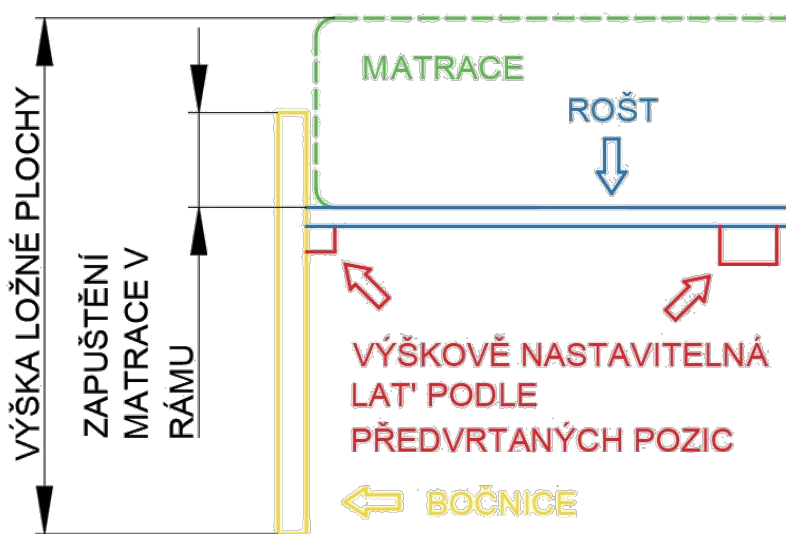

**C**

2 ks

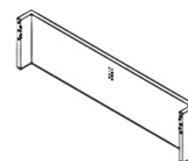

**BO**

2 ks

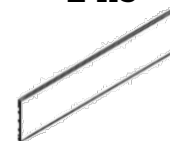

**SL**

1 ks

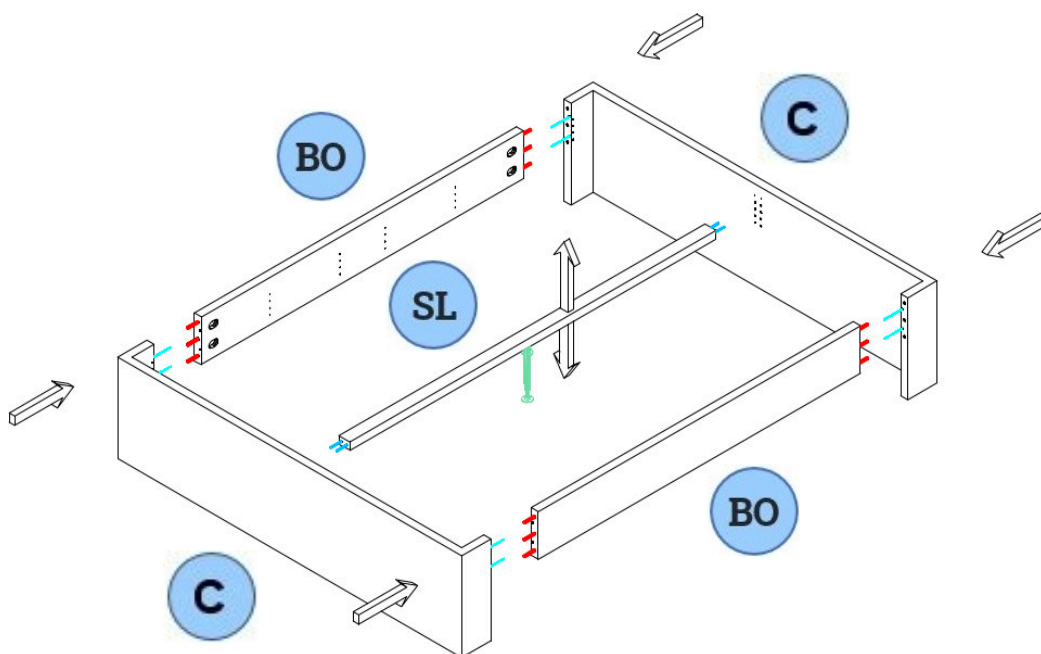



# 5.

Před stažením šroubového spoje pečlivě zkontrolujte, že k sobě dílce bočnice a čela postele dokonale doléhají. V případě nutnosti použijte gumovou paličku. Až poté je možné šroubový spoj dotáhnout.

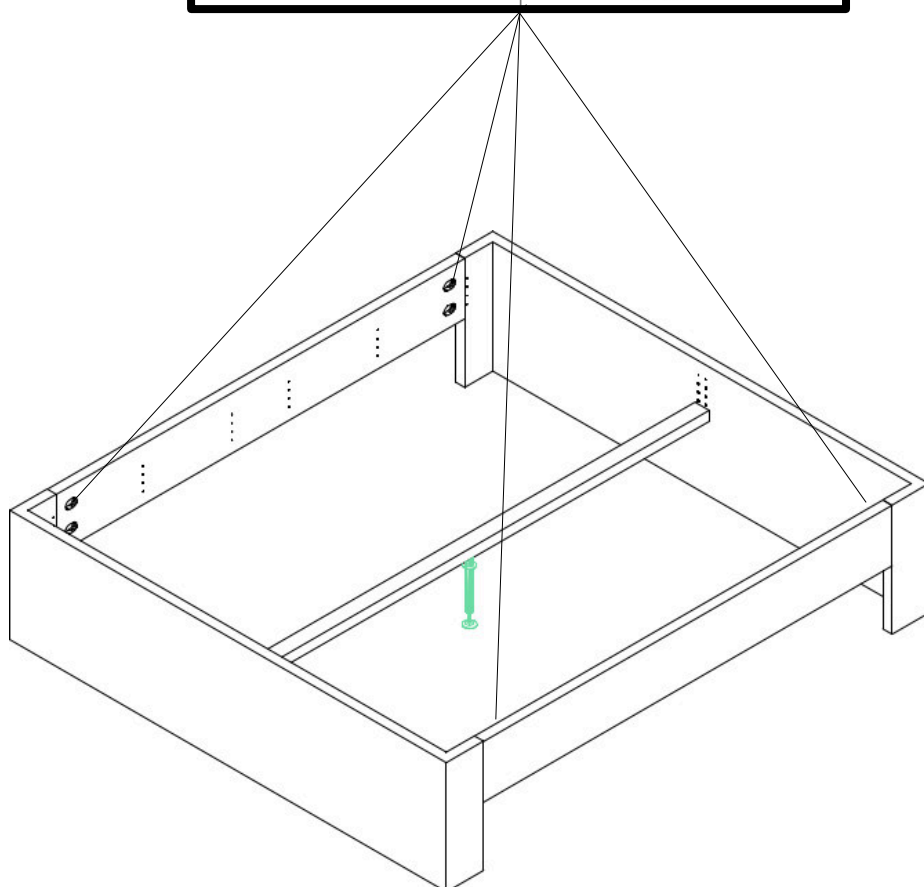
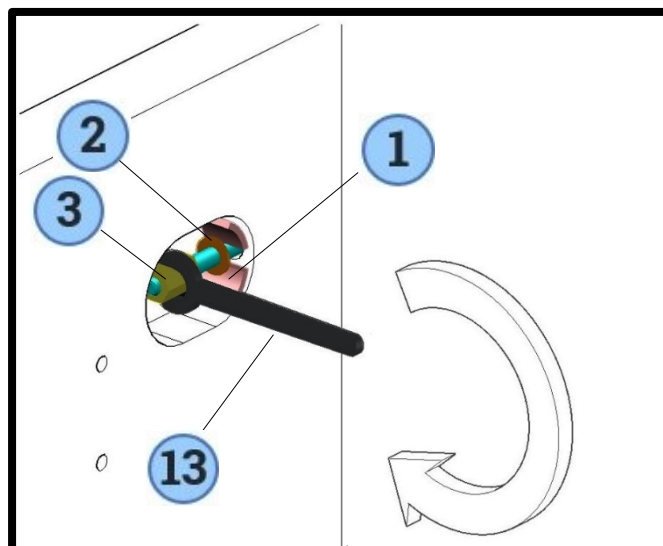

**1**  
8 ks

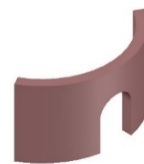

**2**  
8 ks



**3**  
8 ks

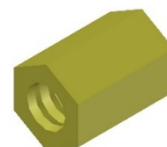

**13**  
1 ks



# 6.

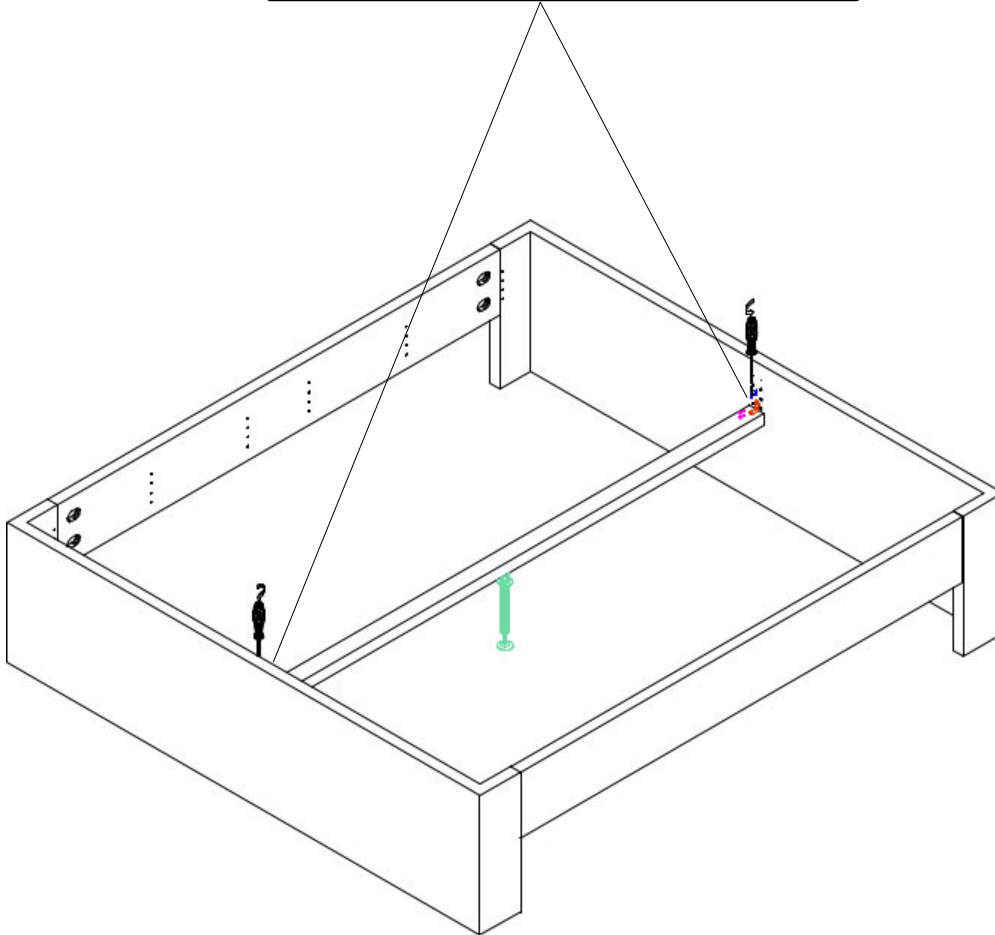
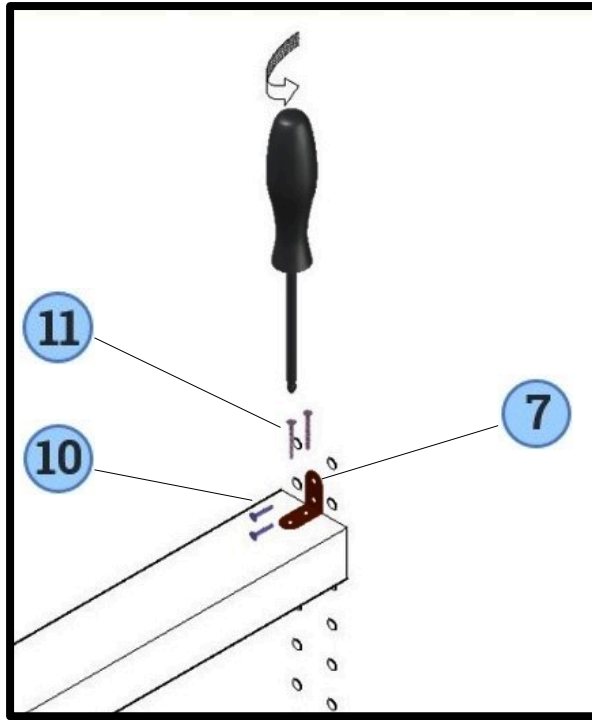

10

4 ks



11

4 ks



7

2 ks

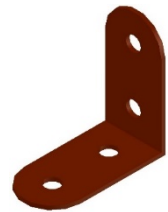

# 7.

## Schéma výšky latí

Latě do bočnic a středovou lať můžete připevnit do několika pozic. Výšková pozice latí ovlivňuje tyto dvě věci:

- 1) Výslednou výšku ložné plochy (pozor, berte v potaz i výšku roštu).
- 2) Kolik cm matrace bude zapuštěno v rámu postele (doporučujeme minimálně 5-8 cm).

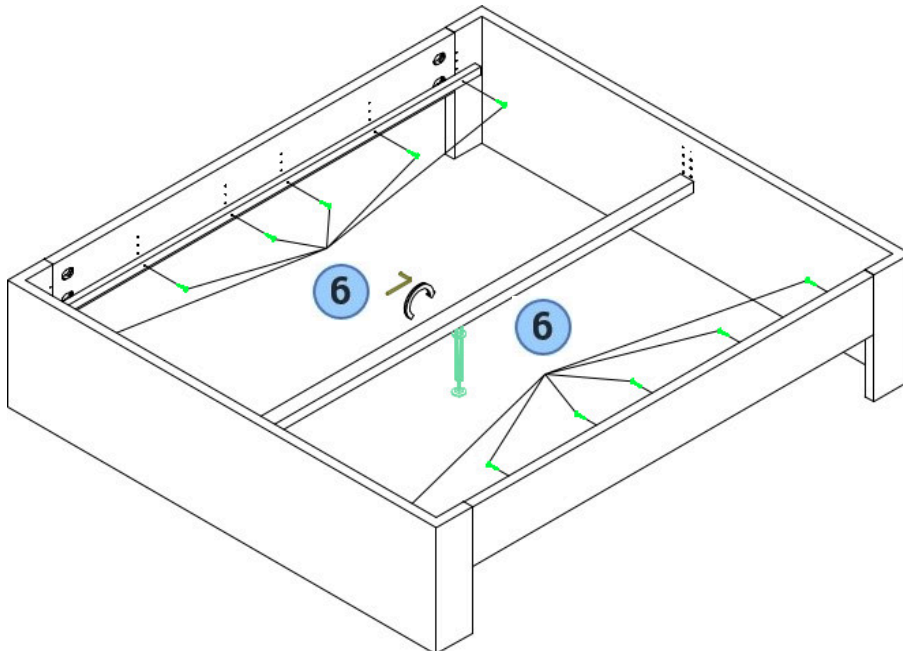
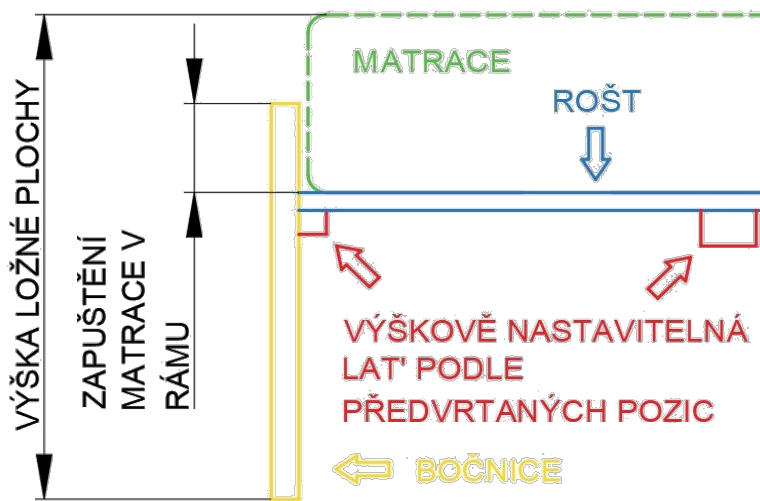

LB

2 ks

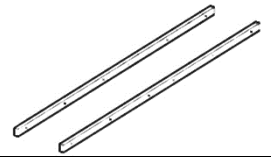

6

TORX  
7x45  
12 ks



12

KLÍČ  
TORX  
1 ks

